

Intara CX

Article number: 51440001

LIGHT TECHNOLOGY

LED	COB
Light colour	830
Luminous flux	3750 lm
System power	34 W
Luminaire Efficiency	113 lm/W
Reflector	Spot
Beam angle	20°

LUMINAIRE

Rotation angle	350°
Swivel angle	+30° / -30°
Weight	0.70 kg
Protection rating . class	IP20 . III
Luminaire colour	black

OPTIONAL

RAL-colours, NCS-colours (powder coating or wet spraying) on inquiry, surface alloys on inquiry, honeycomb louver

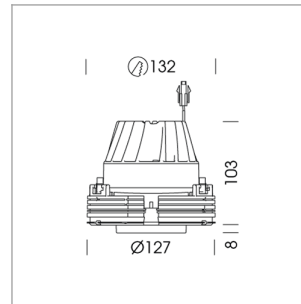

Recessed directional spot, flush with ceiling with LED, rated life of the LED L80/B10 > 50000 h, colour rendering index CRI > 80, chromaticity tolerance 2 SDCM (initial), LED hybrid technology, 3D silicone lens to reduce the proportion of scattered light, reflector with circular light distribution pattern, reflector pure aluminium 99,99% in MIRO-Silver®, segmented and faceted, exchangeable reflector unit in high-sheen black plastic, with glass cover, luminaire head designed as heat sink die-cast aluminium, black anodized, rotation angle 350°, swivel angle +30°/-30°, Ceiling plaster die-cast aluminium, trim plastic injection molding, black, separate driver unit

76500076 driver unit, Fix Current, 220-240 V / 50-60 Hz, 850 mA, camera-compatible, up to 2.5 KV interference resistance, SELV, max. 34 luminaires per circuit (B16A fuse)

76500077 driver unit, DALI, 220-240 V / 50-60 Hz, 850 mA, with GST18/5-pin connector, incl. 5-conductor feed-through wiring, camera-compatible, up to 2.5 KV interference resistance, SELV, max. 24 luminaires per circuit (B16A fuse)

Note: All data are typical values. System features may change with product improvements due to technical advances. Errors excepted.



1.0 m	0.34	21297.0
2.0 m	0.68	5325.0
3.0 m	1.02	2367.0
4.0 m	1.36	1332.0
5.0 m	1.70	852.0
Ø (m)		E0(0°) [lx]

