

Intara CX

Article number: 51470004

LIGHT TECHNOLOGY

LED	COB
Light colour	927
Luminous flux	3350 lm
System power	41 W
Luminaire Efficiency	82 lm/W
Reflector	OvalBasic
Beam angle	60° x 40°

LUMINAIRE

Rotation angle	350°
Swivel angle	+30° / -30°
Weight	0.70 kg
Protection rating . class	IP20 . III
Luminaire colour	black

OPTIONAL

RAL-colours, NCS-colours (powder coating or wet spraying) on inquiry, surface alloys on inquiry, honeycomb louver

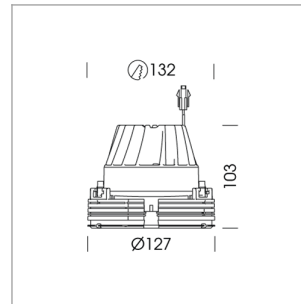

Recessed directional spot, flush with ceiling with LED, rated life of the LED L80/B10 > 50000 h, colour rendering index CRI > 90, chromaticity tolerance 2 SDCM (initial), reflector with oval light distribution pattern, reflector pure aluminium 99,99% in MIRO-Silver®, segmented, exchangeable reflector unit in high-sheen black plastic, with glass cover, luminaire head designed as heat sink die-cast aluminium, black anodized, rotation angle 350°, swivel angle +30°/-30°, Ceiling plaster die-cast aluminum, trim plastic injection molding, black, separate driver unit

76500037 driver unit, Fix Current, 220-240 V / 50-60 Hz, 1050 mA, camera-compatible, up to 2.5 KV interference resistance, SELV, max. 22 luminaires per circuit (B16A fuse)

76500042 driver unit, DALI, 220-240 V / 50-60 Hz, 1050 mA, with GST18/5-pin connector, incl. 5-conductor feed-through wiring, camera-compatible, up to 2.5 KV interference resistance, SELV, max. 22 luminaires per circuit (B16A fuse)

Note: All data are typical values. System features may change with product improvements due to technical advances. Errors excepted.

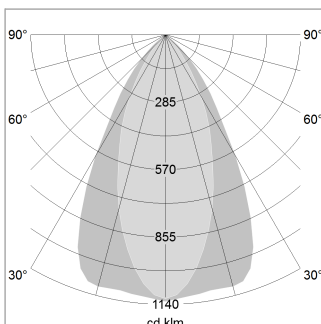

Height (m)	Beam Diameter (m)	Beam Area (m²)	Beam Illuminance (lx)
1.0 m	1.18	0.76	3781.3
2.0 m	2.36	1.52	945.3
3.0 m	3.54	2.28	420.1
4.0 m	4.72	3.04	236.3
5.0 m	5.90	3.80	151.3

Ø (m) E0(0°) [lx]

