

Intara CX

Article number: 51350009

LIGHT TECHNOLOGY

LED	COB
Light colour	840
Luminous flux	1260 lm
System power	15 W
Luminaire Efficiency	84 lm/W
Reflector	NarrowSpot
Beam angle	10°

LUMINAIRE

Rotation angle	350°
Swivel angle	+30° / -30°
Weight	0.72 kg
Protection rating . class	IP20 . III
Luminaire colour	white

OPTIONEEL

RAL-colours, NCS-colours (powder coating or wet spraying) on inquiry, surface alloys on inquiry, honeycomb louver

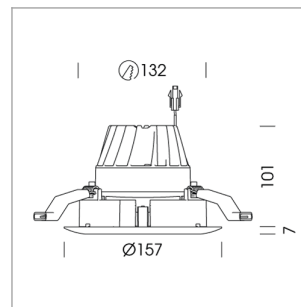

Recessed directional spot with LED, rated life of the LED L80/B10 > 50000 h, colour rendering index CRI > 80, chromaticity tolerance 3 SDCM (initial), LED hybrid technology, 3D silicone lens to reduce the proportion of scattered light, rotation-symmetrical reflector with circular light distribution pattern, reflector pure aluminium 99,99% in MIRO-Silver®, segmented and faceted, exchangeable reflector unit in high-sheen black plastic, with glass cover, luminaire head designed as heat sink die-cast aluminium, black anodized, rotation angle 350°, swivel angle +30°/-30°, assembly ring die-cast aluminium, front ring and trim in plastic, plastic clamp spring for ceiling attachment, white, separate driver unit

76500101 driver unit, Fix Current, IP54,
220-240 V / 50-60 Hz, 400 mA, camera-compatible, up to 2.5 KV interference resistance, SELV, max. 34 luminaires per circuit (B16A fuse)

76500105 driver unit, DALI, IP54,
220-240 V / 50-60 Hz, 400 mA, camera-compatible, up to 2.5 KV interference resistance, SELV, max. 24 luminaires per circuit (B16A fuse)

76500050 driver unit, Fix Current,
220-240 V / 50-60 Hz, 400 mA, camera-compatible, up to 2.5 KV interference resistance, SELV, max. 34 luminaires per circuit (B16A fuse)

76500051 driver unit, DALI,
220-240 V / 50-60 Hz, 400 mA, with GST18/5-pin connector, incl. 5-conductor feed-through wiring, camera-compatible, up to 2.5 KV interference resistance, SELV, max. 24 luminaires per circuit (B16A fuse)

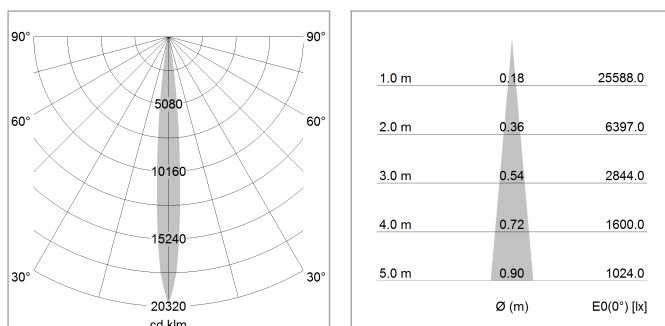

Note: All data are typical values. System features may change with product improvements due to technical advances. Errors excepted.

