

Intara RC 300

Article number: 50370002

LIGHT TECHNOLOGY

LED	SMD Line
Light colour	830
Luminous flux	1600 lm
System power	17 W
Luminaire Efficiency	94 lm/W
Reflector	WallWash
Beam angle	1 x 20°

LUMINAIRE

Weight	0.6 kg
Protection rating . class	IP 20 . III
Luminaire colour	aluminium

OPTIONAL

RAL-colours, NCS-colours (powder coating or wet spraying) on inquiry, surface alloys on inquiry, honeycomb louver

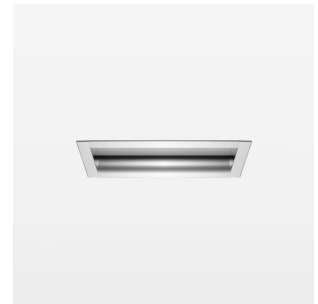
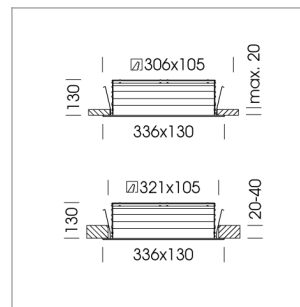

Recessed luminaire with LED, rated life of the LED L80/B10 > 50000 h, colour rendering index CRI > 80, chromaticity tolerance 3 SDCM (initial), reflector with asymmetrical light distribution pattern, reflector pure aluminium 99,99% in MIRO-Silver®, luminaire housing aluminium, aluminium, separate driver unit

76500032 driver unit, Fix Current, 220-240 V / 50-60 Hz, 900 mA, camera-compatible, up to 2.5 KV interference resistance, SELV, max. 24 luminaires per circuit (B16A fuse)

Note: All data are typical values. System features may change with product improvements due to technical advances. Errors excepted.

