

Intara SQ 175

Article number: 51160101

LIGHT TECHNOLOGY

LED	COB
Light colour	Fish-Seafood
Luminous flux	2900 lm
System power	41 W
Luminaire Efficiency	71lm/W
Reflector	OvalBasic
Beam angle	60° x 30°

LUMINAIRE

Swivel angle	30°
Weight	1.9 kg
Protection rating . class	IP 20 . III
Luminaire colour	stratoblack

OPTIONEEL

RAL-colours, NCS-colours (powder coating or wet spraying) on inquiry, surface alloys on inquiry, honeycomb louver

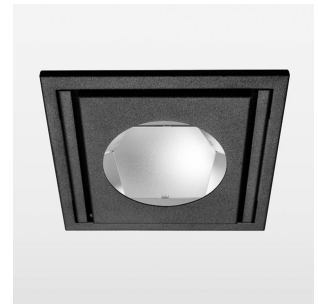
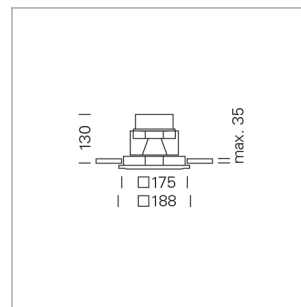

Recessed luminaire with LED, rated life of the LED L80/B10 > 50000 h, colour rendering index CRI > 80, chromaticity tolerance 3 SDCM (initial), reflector with oval light distribution pattern, reflector pure aluminium 99,99% in MIRO-Silver®, swivel angle 30°, luminaire housing sheet steel, powder-coated, stratoblack, separate driver unit

76500037 driver unit, Fix Current, 220-240 V / 50-60 Hz, 1050 mA, camera-compatible, up to 2.5 KV interference resistance, SELV, max. 22 luminaires per circuit (B16A fuse)

76500042 driver unit, DALI, 220-240 V / 50-60 Hz, 1050 mA, with GST18/5-pin connector, incl. 5-conductor feed-through wiring, camera-compatible, up to 2.5 KV interference resistance, SELV, max. 22 luminaires per circuit (B16A fuse)

Note: All data are typical values. System features may change with product improvements due to technical advances. Errors excepted.



1.0 m	1.13 0.71	3766.0
2.0 m	2.26 1.42	942.0
3.0 m	3.39 2.13	419.0
4.0 m	4.52 2.84	236.0
5.0 m	5.65 3.55	151.0
	Ø (m)	E0(0°)(lx)

