

Ontero ID

Article number: 20620025

LIGHT TECHNOLOGY

LED	COB
Light colour	830
Luminous flux	2090 lm
System power	15 W
Luminaire Efficiency	132 lm/W
Reflector	Spot
Beam angle	20°

LUMINAIRE

Rotation angle	330°
Swivel angle	90°
Weight	1.3 kg
Protection rating . class	IP 20 . I
Luminaire colour	stratowhite

OPTIONAL

RAL-colours, NCS-colours (powder coating or wet spraying) on inquiry, surface alloys on inquiry, honeycomb louver

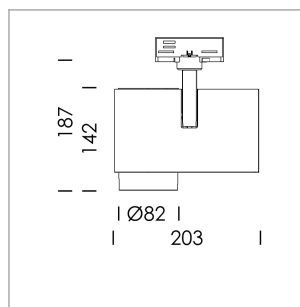

Surface-mounted luminaire with LED, rated life of the LED L80/B10 > 50000 h, colour rendering index CRI > 80, chromaticity tolerance 2 SDCM (initial), LED hybrid technology, 3D silicone lens to reduce the proportion of scattered light, reflector with circular light distribution pattern, reflector pure aluminium 99,99% in MIRO-Silver®, segmented and faceted, exchangeable reflector unit in high-sheen black plastic, with glass cover, rotation angle 330°, swivel angle 90°, luminaire housing die-cast aluminium, powder-coated, stratowhite

Multiadapter black, inclusive driver unit: 220-240 V~ / 50-60 Hz, max. 34 luminaires per circuit (B16A fuse)

Note: All data are typical values. System features may change with product improvements due to technical advances. Errors excepted.



1.0 m	0.34	12291.0
2.0 m	0.68	3073.0
3.0 m	1.02	1366.0
4.0 m	1.36	769.0
5.0 m	1.70	492.0
	Ø (m)	E0(0°)(lx)

