

Ontero XR

Article number: 20770027

LIGHT TECHNOLOGY

LED	COB
Light colour	840
Luminous flux	2100 lm
System power	15 W
Luminaire Efficiency	133 lm/W
Reflector	Spot
Beam angle	20°

LUMINAIRE

Rotation angle	400°
Swivel angle	+85° / -85°
Weight	0.8 kg
Protection rating . class	IP 20 . I
Luminaire colour	stratowhite

OPTIONAL

RAL-colours, NCS-colours (powder coating or wet spraying) on inquiry (only luminaire head and holding arm) surface alloys on inquiry, honeycomb louver, blends

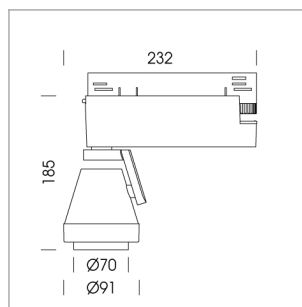

Surface-mounted luminaire with LED, rated life of the LED L80/B10 > 50000 h, colour rendering index CRI > 80, chromaticity tolerance 2 SDCM (initial), reflector with circular light distribution pattern, reflector pure aluminium 99,99% in MIRO-Silver®, segmented and faceted, 3D lens silicon to reduce the proportion of scattered light, rotation angle 400°, swivel angle +85°/-85°, luminaire head/retention arm die-cast aluminium, powder-coated, stratowhite, power-adaptor, black, inclusive fix current driver unit: 220-240 V~ / 50-60 Hz, max. 34 luminaires per circuit (B16A fuse)

Note: All data are typical values. System features may change with product improvements due to technical advances. Errors excepted.

