

Ontero XR

Article number: 20770097

LIGHT TECHNOLOGY

LED	COB
Light colour	927
Luminous flux	2860 lm
System power	34 W
Luminaire Efficiency	84 lm/W
Reflector	Spot
Beam angle	20°

LUMINAIRE

Rotation angle	400°
Swivel angle	+85° / -85°
Weight	0.8 kg
Protection rating . class	IP 20 . I
Luminaire colour	stratosilver

OPTIONAL

RAL-colours, NCS-colours (powder coating or wet spraying) on inquiry (only luminaire head and holding arm) surface alloys on inquiry, honeycomb louver, blends

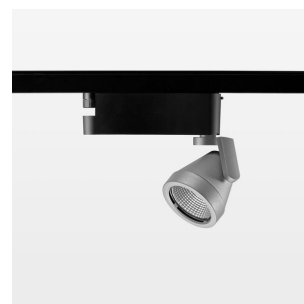
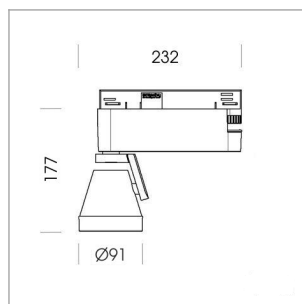

Surface-mounted luminaire with LED, rated life of the LED L80/B10 > 50000 h, colour rendering index CRI > 90, chromaticity tolerance 2 SDCM (initial), reflector with circular light distribution pattern, reflector pure aluminium 99,99% in MIRO-Silver®, segmented and faceted, 3D lens silicon to reduce the proportion of scattered light, rotation angle 400°, swivel angle +85°/-85°, luminaire head/retention arm die-cast aluminium, powder-coated, stratosilver, power-adaptor, black, inclusive fix current driver unit: 220-240 V~ / 50-60 Hz, max. 34 luminaires per circuit (B16A fuse)

Note: All data are typical values. System features may change with product improvements due to technical advances. Errors excepted.

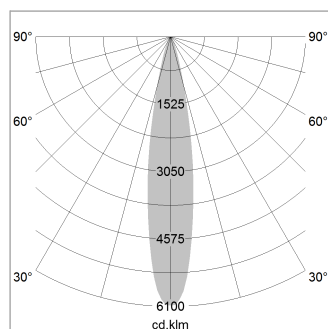

1.0 m	0.34	17402.0
2.0 m	0.68	4350.5
3.0 m	1.02	1933.6
4.0 m	1.36	1087.6
5.0 m	1.70	696.1
	Ø (m)	E0(0°) [lx]

