

## Pendiro ID

Article number: 80650016

### LIGHT TECHNOLOGY

LED	COB
Light colour	927
Luminous flux	1640 lm
System power	15 W
Luminaire Efficiency	104 lm/W
Reflector	Flood
Beam angle	44°

### LUMINAIRE

Weight	0.7 kg
Protection rating . class	IP 20 . III
Luminaire colour	stratosilver

### OPTIONAL

RAL-colours, NCS colours (powder coating or wet spraying) on inquiry, surface alloys on inquiry

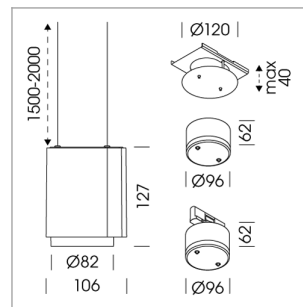

Suspended luminaire with LED, rated life of the LED L80/B10 > 50000 h, colour rendering index CRI > 90, chromaticity tolerance 2 SDCM (initial), reflector with circular light distribution pattern, reflector pure aluminium 99,99% in MIRO-Silver®, segmented and faceted, exchangeable reflector unit in high-sheen black plastic, with glass cover, luminaire housing die-cast aluminium, powder-coated, stratosilver, separate driver unit

76500053 recessed canopy,  
Mounting plate with accessories for recessed fitting, Connecting cable with plug  
connection for driver unit (order separately), cover sheet steel, powder-coated, stratosilver

76500050 driver unit, Fix Current,  
220-240 V / 50-60 Hz, 400 mA, camera-compatible, up to 2.5 KV interference resistance, SELV, max. 34 luminaires per circuit (B16A fuse)

76500051 driver unit, DALI,  
220-240 V / 50-60 Hz, 400 mA, with GST18/5-pin connector, incl. 5-conductor feed-through wiring, camera-compatible, up to 2.5 KV interference resistance, SELV, max. 24 luminaires per circuit (B16A fuse)

76500059 canopy with multiadapter inclusive driver unit,  
220-240 V / 50-60 Hz, 400 mA, up to 2.5 KV interference resistance, SELV, max. 95 pcs. / B16 luminaires per circuit (B16A fuse), cover sheet steel, powder-coated, stratoblack

76500060 canopy inclusive DALI driver unit,  
220-240 V / 50-60 Hz, 400 mA, up to 2.5 KV interference resistance, SELV, max. 95 pcs. / B16 luminaires per circuit (B16A fuse), cover sheet steel, powder-coated, stratoblack

Note: All data are typical values. System features may change with product improvements due to technical advances. Errors excepted.

