

Intara RC 600

Article number: 50350002

LIGHT TECHNOLOGY

LED	SMD Line
Light colour	830
Luminous flux	3190 lm
System power	33 W
Luminaire Efficiency	97 lm/W
Reflector	WallWash
Beam angle	1 x 20°

LUMINAIRE

Weight	0.9kg without driver
Protection rating . class	IP 20 . III
Luminaire colour	black

OPTIONEEL

Profile aperture
DALI driver on request

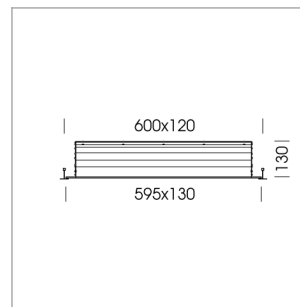

Recessed luminaire for grid ceiling with LED, rated life of the LED L80/B10 > 50000 h, color rendering index CRI > 80, chromaticity point tolerance 3 SDCM (initial), Reflector with asymmetrical light distribution pattern, 99.99% pure aluminium reflector made of MIRO-SILVER®, aluminium luminaire housing and frame, anodized, separate driver unit.

If ceiling systems with bevelled inlay panels are used additional profile must be used (product number: 5036 0000 00114). Please order these separately for each luminaire.

76500032 driver unit, fix current
220-240 V / 50-60 Hz, 900 mA, with GST18/3-pin connector, incl. 3-conductor feed-through wiring, camera-compatible, up to 2.5 KV interference resistance, SELV, max. 52 Stk. / B16 luminaires per circuit (B16A fuse)

Note: All data are typical values. System features may change with product improvements due to technical advances. Errors excepted.

