

Intara SQ 175

Article number: 51070055

LIGHT TECHNOLOGY

LED	COB
Light colour	927
Luminous flux	3270 lm
System power	34 W
Luminaire Efficiency	98 lm/W
Reflector	OvalBasic
Beam angle	60° x 30°

LUMINAIRE

Swivel angle	30°
Weight	1.9 kg
Protection rating . class	IP 20 . III
Luminaire colour	stratosilver

OPTIONAL

RAL-colours, NCS-colours (powder coating or wet spraying) on inquiry, surface alloys on inquiry, honeycomb louver

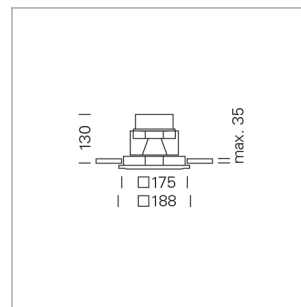

Recessed luminaire with LED, rated life of the LED L80/B10 > 50000 h, colour rendering index CRI > 90, chromaticity tolerance 2 SDCM (initial), reflector with oval light distribution pattern, reflector pure aluminium 99,99% in MIRO-Silver®, swivel angle 30°, luminaire housing sheet steel, powder-coated, stratosilver, separate driver unit

76500076 driver unit, Fix Current, 220-240 V / 50-60 Hz, 850 mA, camera-compatible, up to 2.5 KV interference resistance, SELV, max. 34 luminaires per circuit (B16A fuse)

76500077 driver unit, DALI, 220-240 V / 50-60 Hz, 850 mA, with GST18/5-pin connector, incl. 5-conductor feed-through wiring, camera-compatible, up to 2.5 KV interference resistance, SELV, max. 24 luminaires per circuit (B16A fuse)

Note: All data are typical values. System features may change with product improvements due to technical advances. Errors excepted.



Height (m)	Beam Diameter (m)	Beam Area (m²)	Illuminance E0(0°) (lx)
1.0	1.05	0.41	5091.9
2.0	2.10	0.82	1273.0
3.0	3.15	1.22	565.8
4.0	4.20	1.63	318.2
5.0	5.25	2.04	203.7

