

Intara SQ 175

Article number: 51070112

LIGHT TECHNOLOGY

LED	COB
Light colour	SpecialMeat
Luminous flux	1920 lm
System power	34 W
Luminaire Efficiency	57 lm/W
Reflector	OvalBasic
Beam angle	60° x 30°

LUMINAIRE

Swivel angle	30°
Weight	1.9 kg
Protection rating . class	IP 20 . III
Luminaire colour	stratowhite

OPTIONAL

RAL-colours, NCS-colours (powder coating or wet spraying) on inquiry, surface alloys on inquiry, honeycomb louver

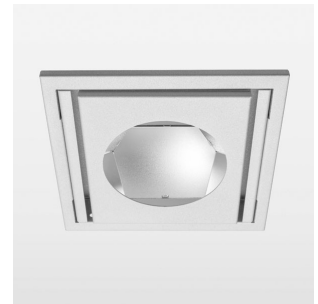
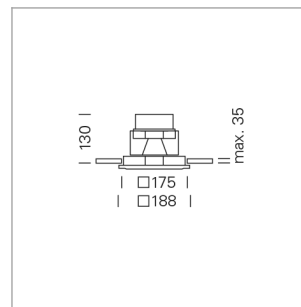

Recessed luminaire with LED, rated life of the LED L80/B10 > 50000 h, chromaticity tolerance 2 SDCM (initial), reflector with oval light distribution pattern, reflector pure aluminium 99,99% in MIRO-Silver®, swivel angle 30°, luminaire housing sheet steel, powder-coated, stratowhite, separate driver unit

76500076 driver unit, Fix Current, 220-240 V / 50-60 Hz, 850 mA, camera-compatible, up to 2.5 KV interference resistance, SELV, max. 34 luminaires per circuit (B16A fuse)

76500077 driver unit, DALI, 220-240 V / 50-60 Hz, 850 mA, with GST18/5-pin connector, incl. 5-conductor feed-through wiring, camera-compatible, up to 2.5 KV interference resistance, SELV, max. 24 luminaires per circuit (B16A fuse)

Note: All data are typical values. System features may change with product improvements due to technical advances. Errors excepted.

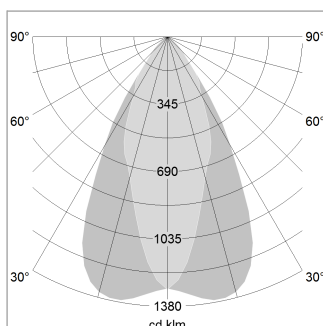

1.0 m	1.05 0.41	2989.7
2.0 m	2.10 0.82	747.4
3.0 m	3.15 1.22	332.2
4.0 m	4.20 1.63	186.9
5.0 m	5.25 2.04	119.6
	Ø (m)	E0(0°) [lx]

