

## Intara XR

Article number: 50700034

### LIGHT TECHNOLOGY

LED	COB
Light colour	PearlWhite
Luminous flux	2340 lm
System power	23 W
Luminaire Efficiency	102 lm/W
Reflector	Spot
Beam angle	20°

### LUMINAIRE

Rotation angle	400°
Swivel angle	+85° / -85°
Weight	0.65 kg
Protection rating . class	IP 20 . II
Luminaire colour	stratowhite

### OPTIONEEL

RAL-colours, NCS-colours (powder coating or wet spraying) on inquiry, surface alloys on inquiry, honeycomb louver

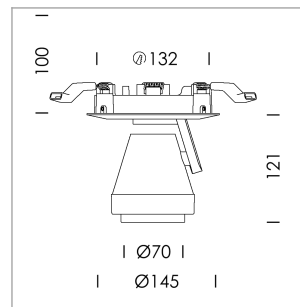

Semi-recessed luminaire with LED, rated life of the LED L80/B10 > 50000 h, colour rendering index CRI > 90, chromaticity tolerance 2 SDCM (initial), rotation-symmetrical reflector with circular light distribution pattern, reflector pure aluminium 99,99% in MIRO-Silver®, segmented and faceted, 3D lens silicon to reduce the proportion of scattered light, die-cast aluminium, powder-coated, rotation angle 400°, swivel angle +85° / -85°, stratowhite, separate driver unit

76500034 driver unit, Fix Current, 220-240 V / 50-60 Hz, 600 mA, camera-compatible, up to 2.5 KV interference resistance, SELV, max. 34 luminaires per circuit (B16A fuse)

76500039 driver unit, DALI, 220-240 V / 50-60 Hz, 600 mA, with GST18/5-pin connector, incl. 5-conductor feed-through wiring, camera-compatible, up to 2.5 KV interference resistance, SELV, max. 24 luminaires per circuit (B16A fuse)

Note: All data are typical values. System features may change with product improvements due to technical advances. Errors excepted.

