

Intara XR

Article number: 50780011

LIGHT TECHNOLOGY

LED	COB
Light colour	927
Luminous flux	3430 lm
System power	41 W
Luminaire Efficiency	84 lm/W
Reflector	OvalBasic
Beam angle	60° x 40°

LUMINAIRE

Rotation angle	400°
Swivel angle	+85°/-85°
Weight	0.65 kg
Protection rating . class	IP 20 . II
Luminaire colour	stratosilver

OPTIONEEL

RAL-colours, NCS-colours (powder coating or wet spraying) on inquiry, surface alloys on inquiry, honeycomb louver

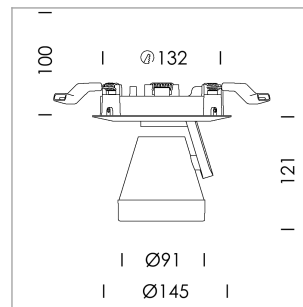

Semi-recessed luminaire with LED, rated life of the LED L80/B10 > 50000 h, colour rendering index CRI > 90, chromaticity tolerance 2 SDCM (initial), reflector with oval light distribution pattern, reflector pure aluminium 99,99% in MIRO-Silver®, segmented, die-cast aluminium, powder-coated, rotation angle 400°, swivel angle +85°/-85°, stratosilver, potentiometer to adjust the brightness, separate driver unit

76500109 driver unit, Fix Current, 220-240 V / 50-60 Hz, 1050 mA, camera-compatible, up to 2.5 KV interference resistance, SELV, max. 22 luminaires per circuit (B16A fuse)

Note: All data are typical values. System features may change with product improvements due to technical advances. Errors excepted.

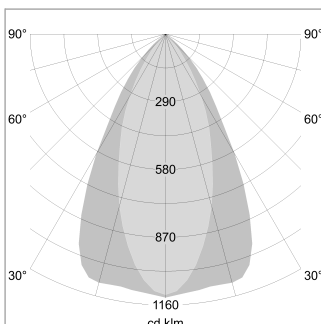

1.0 m	1.14 0.76	3771.6
2.0 m	2.28 1.53	942.9
3.0 m	3.42 2.29	419.1
4.0 m	4.56 3.05	235.7
5.0 m	5.70 3.82	150.9
	Ø (m)	E0(0°) [lx]

