

Intara TX

Article number: 50820005

LIGHT TECHNOLOGY

| | |
|----------------------|----------------|
| LED | SMD-Board |
| Light colour | 835 |
| Luminous flux | 6320 lm |
| System power | 45 W |
| Luminaire Efficiency | 140 lm/W |
| Reflector | Xtra WideFlood |
| Beam angle | 90° |

LUMINAIRE

| | |
|---------------------------|------------|
| Weight | 3.2 kg |
| Protection rating . class | IP 20 . I |
| Luminaire colour | matt white |

OPTIONAL

Accessories for feed-through wiring,
cover stripes

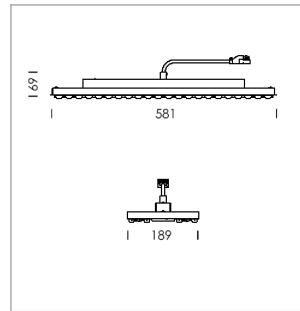

Lay in luminaire with LED, rated life of the LED L80/B50 > 50000 h, colour rendering index CRI > 80, chromaticity tolerance 3 SDCM (initial), extra wide, homogeneous light distribution pattern, TIR-lens made of PMMA, luminaire housing sheet steel, powder-coated, matt white

Driver with adjustable system power in 8 steps (38 W to 64 W), choice by DIP-Switch, 220-240 V~ / 50-60 Hz, max. 16 Pcs. luminaires per circuit (B16A fuse).

Order ceiling attachment with visible supporting profile separately:
5080Z600 B-Set for Ceiling Systems 600
5080Z625 B-Set for Ceiling Systems 625

Note: All data are typical values. System features may change with product improvements due to technical advances. Errors excepted.

