

Intara TX

Article number: 50850006

LIGHT TECHNOLOGY

LED	SMD-Board
Light colour	840
Luminous flux	6410 lm
System power	45 W
Luminaire Efficiency	142 lm/W
Reflector	Xtra WideFlood
Beam angle	90°

LUMINAIRE

Weight	3.2 kg
Protection rating . class	IP 20 . I
Luminaire colour	matt white

OPTIONAL

Accessories for feed-through wiring,
cover stripes

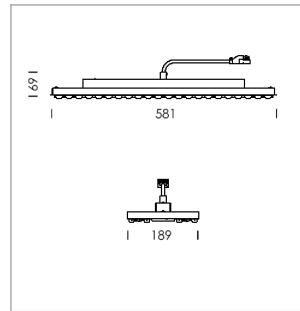

Lay in luminaire with LED, rated life of the LED L80/B50 > 50000 h, colour rendering index CRI > 80, chromaticity tolerance 3 SDCM (initial), extra wide, homogeneous light distribution pattern, TIR-lens made of PMMA, luminaire housing sheet steel, powder-coated, matt white

Driver with adjustable system power in 8 steps (38 W to 64 W), choice by DIP-Switch, 220-240 V~ / 50-60 Hz, max. 16 Pcs. luminaires per circuit (B16A fuse).

Order ceiling attachment with visible supporting profile separately:
5080Z600 B-Set for Ceiling Systems 600
5080Z625 B-Set for Ceiling Systems 625

Note: All data are typical values. System features may change with product improvements due to technical advances. Errors excepted.

