

## Ontero CS 90

Article number: 20520010

### LIGHT TECHNOLOGY

LED	COB
Light colour	830
Luminous flux	2900 lm
System power	23 W
Luminaire Efficiency	125 lm/W
Reflector	Flood
Beam angle	43°

### LUMINAIRE

Rotation angle	350°
Swivel angle	+180° / -20°
Weight	1.3 kg
Protection rating . class	IP 20 . I
Luminaire colour	stratowhite

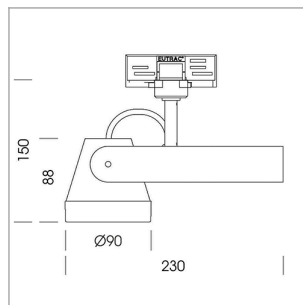

Surface-mounted luminaire with LED, rated life of the LED L80/B10 > 50000 h, colour rendering index CRI > 80, chromaticity tolerance 2 SDCM (initial), reflector with circular light distribution pattern, reflector pure aluminium 99,99% in MIRO-Silver®, luminaire head die-cast aluminium, powder-coated, rotation angle 350°, swivel angle +180°/-20°, luminaire housing sheet steel, powder-coated, stratowhite

Multiadapter black, inclusive driver unit: 220-240 V~ / 50-60 Hz, max. 34 luminaires per circuit (B16A fuse)

Note: All data are typical values. System features may change with product improvements due to technical advances. Errors excepted.



1.0 m	0.79	5100.0
2.0 m	1.58	1275.0
3.0 m	2.37	567.0
4.0 m	3.16	319.0
5.0 m	3.95	204.0
	Ø (m)	E0(0°)(lx)

