

## Intara RD 164

Article number: 50650001

### LIGHT TECHNOLOGY

LED	COB
Light colour	830
Luminous flux	4150 lm
System power	34W
Luminaire Efficiency	122 lm/W
Reflector	Medium
Beam angle	20°

### LUMINAIRE

Swivel angle	+30° / -30°
Weight	0.9kg without driver
Protection rating . class	IP 20 . III
Luminaire colour	black

### OPTIONAL

RAL colours

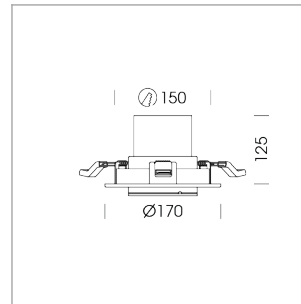

Recessed luminaire with LED, rated life of the LED L80/B10 > 50000h, colour rendering index CRI > 80, chromaticity tolerance 2 SDCM (initial), reflector with circular light distribution pattern, 99,99% pure aluminium, segmented and faceted, cardanic, incl. glass cover, sheet metal powder coated, separate driver unit

76500076 driver unit, fix current  
220-240 V / 50-60 Hz, 850 mA, with GST18/3-pin connector, incl. 3-conductor feed-through wiring, camera-compatible, up to 2.5 KV interference resistance, SELV, max. 34 luminaires per circuit (B16A fuse)

76500077 driver unit, DALI  
220-240 V / 50-60 Hz, 850 mA, with GST18/5-pin connector, incl. 5-conductor feed-through wiring, up to 2.5 KV interference resistance, SELV, max. 24 luminaires per circuit (B16A fuse)

Note: All data are typical values. System features may change with product improvements due to technical advances. Errors excepted.

