

Ontero TX

Article number: 21400005

LIGHT TECHNOLOGY

LED	SMD-Board
Light colour	835
Luminous flux	5920 - 10450 lm
System power	38 W - 72 W
Luminaire Efficiency	156 lm/W - 145 lm/W
Reflector	doppelt asymmetrisch
Beam angle	2 x 20°

LUMINAIRE

Rotation angle	330°
Weight	3.1 kg
Protection rating . class	IP 20 . I
Luminaire colour	matt white

OPTIONAL

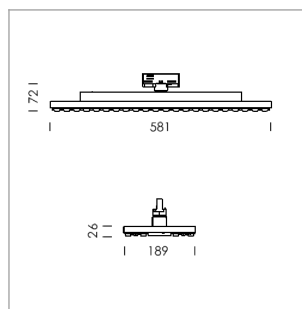

Surface-mounted luminaire with LED, rated life of the LED L80/B50 > 50000 h, colour rendering index CRI > 80, chromaticity tolerance 3 SDCM (initial), double asymmetrical light distribution pattern, lens made of PMMA, Driver with power selection via DIP switch, 8 possible levels: 38 W (5680 lm), 42 W (6300 lm), 47 W (6880 lm), 52 W (7480 lm), 57 W (8070 lm), 62 W (8620 lm), 67 W (9190lm), 72 W (9750 lm), 62 Watt preselected, rotation angle 330°, luminaire housing sheet steel, powder-coated, matt white,

inclusiv driver unit: 220-240 V~ / 50-60 Hz, DALI, max. 15 luminaires per circuit (B16A fuse), temperature protection

Note: All data are typical values. System features may change with product improvements due to technical advances. Errors excepted.

