

## Intara TX

Article number: 50800001

### LIGHT TECHNOLOGY

LED	SMD-Board
Light colour	830
Luminous flux	7670 lm
System power	56 W
Luminaire Efficiency	137 lm/W
Reflector	doppelt asymmetrisch
Beam angle	2 x 20°

### LUMINAIRE

Weight	3.2 kg
Protection rating . class	IP 20 . I
Luminaire colour	matt black

### OPTIONAL

Accessories for feed-through wiring,  
cover stripes

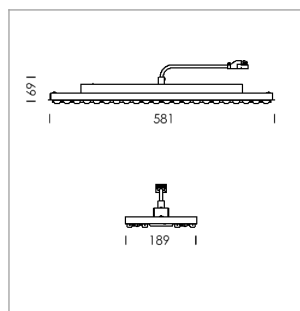

Lay in luminaire with LED, rated life of the LED L80/B50 > 50000 h, colour rendering index CRI > 80, chromaticity tolerance 3 SDCM (initial), double asymmetrical light distribution pattern, lens made of PMMA, luminaire housing sheet steel, powder-coated, matt black

Driver with adjustable system power in 8 steps (38 W to 64 W), choice by DIP-Switch, 220-240 V~ / 50-60 Hz, max. 16 Pcs. luminaires per circuit (B16A fuse).

Order ceiling attachment with visible supporting profile separately:  
5080Z600 B-Set for Ceiling Systems 600  
5080Z625 B-Set for Ceiling Systems 625

Note: All data are typical values. System features may change with product improvements due to technical advances. Errors excepted.

