

Intara CX

Article number: 51480015

LIGHT TECHNOLOGY

LED	COB
Light colour	840
Luminous flux	2680 lm
System power	23 W
Luminaire Efficiency	136 lm/W
Reflector	WallWash

LUMINAIRE

Rotation angle	350°
Swivel angle	+15° / -15°
Weight	0.78 kg
Protection rating . class	IP20 . III
Luminaire colour	black

OPTIONAL

RAL-colours, NCS-colours (powder coating or wet spraying) on inquiry, surface alloys on inquiry, honeycomb louver

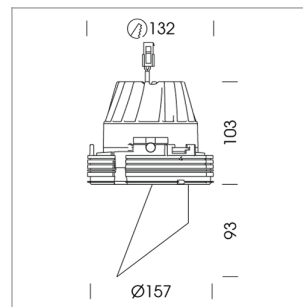

Recessed wallwasher, flush with ceiling with LED, rated life of the LED L80/B10 > 50000 h, colour rendering index CRI > 80, chromaticity tolerance 2 SDCM (initial), reflector with asymmetrical light distribution pattern, primary reflector and kick reflector 99% pure aluminium in MIRO-Silver®, attachment with kick reflector for light cone projection, exchangeable reflector unit in high-sheen black plastic, with glass cover, luminaire head designed as heat sink die-cast aluminium, black anodized, rotation angle 350°, swivel angle +15°/-15°, Ceiling plaster die-cast aluminum, trim plastic injection molding, black, separate driver unit

76500034 driver unit, Fix Current,
220-240 V / 50-60 Hz, 600 mA, camera-compatible, up to 2.5 KV interference resistance, SELV, max. 34 luminaires per circuit (B16A fuse)

76500039 driver unit, DALI,
220-240 V / 50-60 Hz, 600 mA, with GST18/5-pin connector, incl. 5-conductor feed-through wiring, camera-compatible, up to 2.5 KV interference resistance, SELV, max. 24 luminaires per circuit (B16A fuse)

Note: All data are typical values. System features may change with product improvements due to technical advances. Errors excepted.

