

## Intara CX

Article number: 51490004

### LIGHT TECHNOLOGY

LED	COB
Light colour	927
Luminous flux	1290 lm
System power	15 W
Luminaire Efficiency	83 lm/W
Reflector	Downlight
Beam angle	60°

### LUMINAIRE

Weight	0.65 kg
Protection rating . class	IP 20 . III
Luminaire colour	black

### OPTIONAL

RAL-colours, NCS-colours (powder coating or wet spraying) on inquiry, surface alloys on inquiry, honeycomb louver

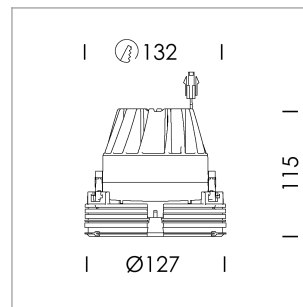

Recessed downlight, flush with ceiling with LED, rated life of the LED L80/B10 > 50000 h, colour rendering index CRI > 90, chromaticity tolerance 2 SDCM (initial), reflector with homogeneous light distribution pattern, diffuser lens, translucent, darklight reflector, aluminium, metallised, highgloss, luminaire head die-cast aluminium, black anodized black anodized, Ceiling plaster die-cast aluminum, trim plastic injection molding, black, separate driver unit

76500050 driver unit, Fix Current, 220-240 V / 50-60 Hz, 400 mA, camera-compatible, up to 2.5 KV interference resistance, SELV, max. 34 luminaires per circuit (B16A fuse)

76500051 driver unit, DALI, 220-240 V / 50-60 Hz, 400 mA, with GST18/5-pin connector, incl. 5-conductor feed-through wiring, camera-compatible, up to 2.5 KV interference resistance, SELV, max. 24 luminaires per circuit (B16A fuse)

Note: All data are typical values. System features may change with product improvements due to technical advances. Errors excepted.

