

Intara CX

Article number: 51490011

LIGHT TECHNOLOGY

LED	COB
Light colour	SpecialMeat
Luminous flux	1620 lm
System power	41 W
Luminaire Efficiency	40 lm/W
Reflector	Downlight
Beam angle	60°

LUMINAIRE

Weight	0.65 kg
Protection rating . class	IP 20 . III
Luminaire colour	black

OPTIONAL

RAL-colours, NCS-colours (powder coating or wet spraying) on inquiry, surface alloys on inquiry, honeycomb louver

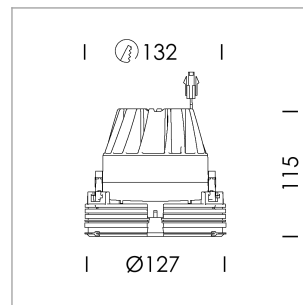

Recessed downlight, flush with ceiling with LED, rated life of the LED L80/B10 > 50000 h, chromaticity tolerance 2 SDCM (initial), reflector with homogeneous light distribution pattern, diffuser lens, translucent, darklight reflector, aluminium, metallised, highgloss, luminaire head die-cast aluminium, black anodized

black anodized, Ceiling plaster die-cast aluminum, trim plastic injection molding, black, separate driver unit

76500037 driver unit, Fix Current, 220-240 V / 50-60 Hz, 1050 mA, camera-compatible, up to 2.5 KV interference resistance, SELV, max. 22 luminaires per circuit (B16A fuse)

76500042 driver unit, DALI, 220-240 V / 50-60 Hz, 1050 mA, with GST18/5-pin connector, incl. 5-conductor feed-through wiring, camera-compatible, up to 2.5 KV interference resistance, SELV, max. 22 luminaires per circuit (B16A fuse)

Note: All data are typical values. System features may change with product improvements due to technical advances. Errors excepted.

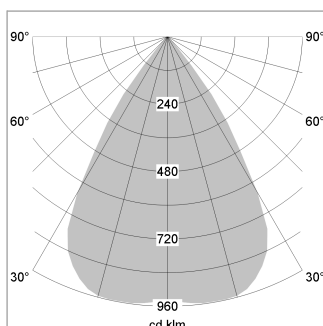

1.0 m	1.28	1526.9
2.0 m	2.56	381.7
3.0 m	3.84	169.7
4.0 m	5.12	95.4
5.0 m	6.40	61.1
Ø (m)		E0(0°) [lx]

