

Intara RD 164

Article number: 50650022

LIGHT TECHNOLOGY

LED	COB
Light colour	927
Luminous flux	3680 lm
System power	41W
Luminaire Efficiency	90 lm/W
Reflector	Flood
Beam angle	30°

LUMINAIRE

Swivel angle	+30° / -30°
Weight	0.9kg without driver
Protection rating . class	IP 20 . III
Luminaire colour	black

OPTIONEEL

RAL colours

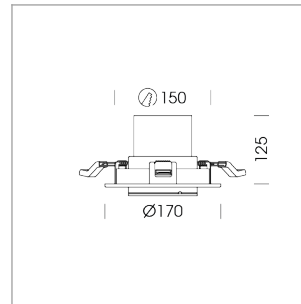

Recessed luminaire with LED, rated life of the LED L80/B10 > 50000h, colour rendering index CRI > 90, chromaticity tolerance 2 SDCM (initial), axially symmetrical reflector with circular light distribution pattern, 99,99% pure aluminium, segmented and faceted, cardanic, incl. glass cover, sheet metal powder coated, separate driver unit

76500037 driver unit, fix current
220-240 V / 50-60 Hz, 1050 mA, with GST18/3-pin connector, incl. 3-conductor feed-through wiring, camera-compatible, up to 2.5 KV interference resistance, SELV, max. 24 luminaires per circuit (B16A fuse)

76500042 driver unit, DALI
220-240 V / 50-60 Hz, 1050 mA, with GST18/5-pin connector, incl. 5-conductor feed-through wiring, up to 2.5 KV interference resistance, SELV, max. 52 luminaires per circuit (B16A fuse)

Note: All data are typical values. System features may change with product improvements due to technical advances. Errors excepted.

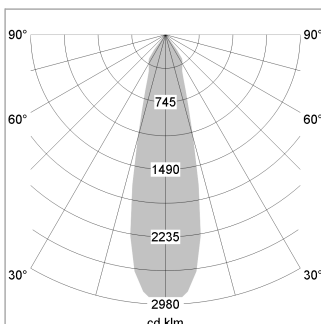

1.0 m	0.48	9907.5
2.0 m	0.96	2476.9
3.0 m	1.44	1100.8
4.0 m	1.92	619.2
5.0 m	2.40	396.3
Ø (m)		E0(0°) [lx]

