

## Intara RD 190

Article number: 51300007

### LIGHT TECHNOLOGY

LED	COB
Light colour	840
Luminous flux	9530 lm
System power	78 W
Luminaire Efficiency	122 lm/W
Reflector	BatWing
Beam angle	2 x 25°

### LUMINAIRE

Rotation angle	170°
Swivel angle	2 x 30°
Weight	1.2 kg
Protection rating . class	IP 20 . III
Luminaire colour	stratosilver

### OPTIONEEL

RAL colours  
Mounting Accessories  
DALI Driver Unit

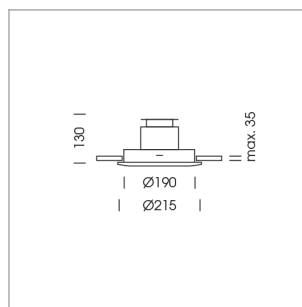

Recessed luminaire with LED, rated life of the LED L80/B10 > 50000 h, colour rendering index CRI > 80, chromaticity tolerance 3 SDCM (initial), reflector with double asymmetrical light distribution pattern, reflector pure aluminium 99,99% in MIRO-Silver®, rotation angle 170°, swivel angle +30°/-30°, luminaire housing sheet steel, powder-coated, stratosilver

Multiadapter black, inclusive driver unit: 220-240 V~ / 50-60 Hz, max. 40 luminaires per circuit (B16A fuse)

Note: All data are typical values. System features may change with product improvements due to technical advances. Errors excepted.

