

## Intara RD 190

Article number: 51330031

### LIGHT TECHNOLOGY

|                      |            |
|----------------------|------------|
| LED                  | COB        |
| Light colour         | PearlWhite |
| Luminous flux        | 2830 lm    |
| System power         | 28 W       |
| Luminaire Efficiency | 117 lm/W   |
| Reflector            | WallBeam   |

### LUMINAIRE

|                           |             |
|---------------------------|-------------|
| Rotation angle            | 170°        |
| Swivel angle              | 15°         |
| Weight                    | 1.4 kg      |
| Protection rating . class | IP 20 . III |
| Luminaire colour          | stratowhite |

### OPTIONEEL

RAL-colours, NCS-colours (powder coating or wet spraying) on inquiry, surface alloys on inquiry, honeycomb louver

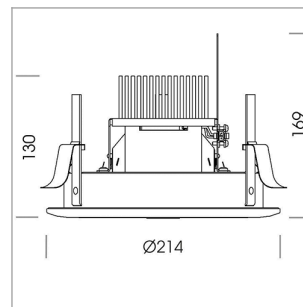

Recessed luminaire with LED, rated life of the LED L80/B10 > 50000 h, colour rendering index CRI > 90, chromaticity tolerance 2 SDCM (initial), reflector with asymmetrical light distribution pattern, reflector pure aluminium 99,99% in MIRO-Silver®, rotation angle 170°, swivel angle 15°, luminaire housing sheet steel, powder-coated, stratowhite, separate driver unit

76500035 driver unit, Fix Current, 220-240 V / 50-60 Hz, 700 mA, camera-compatible, up to 2.5 KV interference resistance, SELV, max. 34 luminaires per circuit (B16A fuse)

76500040 driver unit, DALI, 220-240 V / 50-60 Hz, 700 mA, with GST18/5-pin connector, incl. 5-conductor feed-through wiring, camera-compatible, up to 2.5 KV interference resistance, SELV, max. 24 luminaires per circuit (B16A fuse)

Note: All data are typical values. System features may change with product improvements due to technical advances. Errors excepted.

