

Intara SQ 174

Article number: 50660020

LIGHT TECHNOLOGY

LED	COB
Light colour	835
Luminous flux	4340 lm
System power	41 W
Luminaire Efficiency	106 lm/W
Reflector	Flood
Beam angle	30°

LUMINAIRE

Swivel angle	+30° / -30°
Weight	1.1 kg
Protection rating . class	IP 20 . III
Luminaire colour	stratoblack

OPTIONAL

RAL colours

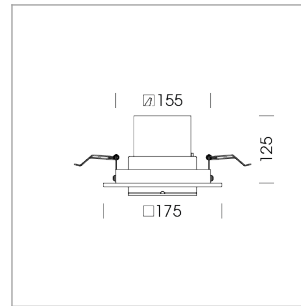

Recessed luminaire with LED, rated life of the LED L80/B10 > 50000 h, colour rendering index CRI > 80, chromaticity tolerance 2 SDCM (initial), reflector with circular light distribution pattern, reflector pure aluminium 99,99% in MIRO-Silver®, cardanic, swivel angle +30°/-30°, luminaire housing sheet steel, powder-coated, stratoblack, separate driver unit

76500037 driver unit, fix current
220-240 V / 50-60 Hz, 1050 mA, with GST18/3-pin connector, incl. 3-conductor feed-through wiring, camera-compatible, up to 2.5 KV interference resistance, SELV, max. 22 luminaires per circuit (B16A fuse)

76500042 driver unit, DALI
220-240 V / 50-60 Hz, 1050 mA, with GST18/5-pin connector, incl. 5-conductor feed-through wiring, camera-compatible, up to 2.5 KV interference resistance, SELV, max. 52 luminaires per circuit (B16A fuse)

Note: All data are typical values. System features may change with product improvements due to technical advances. Errors excepted.

