

Intara SQ 175

Article number: 51340001

LIGHT TECHNOLOGY

LED	COB
Light colour	830
Luminous flux	3420 lm
System power	28 W
Luminaire Efficiency	142 lm/W
Reflector	WallBeam

LUMINAIRE

Swivel angle	30°
Weight	1.8 kg
Protection rating . class	IP 20 . III
Luminaire colour	stratoblack

OPTIONEEL

RAL-colours, NCS-colours (powder coating or wet spraying) on inquiry, surface alloys on inquiry, honeycomb louver

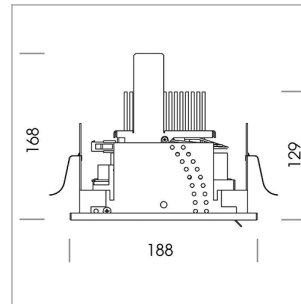

Recessed luminaire with LED, rated life of the LED L80/B10 > 50000 h, colour rendering index CRI > 80, chromaticity tolerance 2 SDCM (initial), reflector with asymmetrical light distribution pattern, reflector pure aluminium 99,99% in MIRO-Silver®, swivel angle 30°, luminaire housing sheet steel, powder-coated, stratoblack, separate driver unit

76500035 driver unit, Fix Current, 220-240 V / 50-60 Hz, 700 mA, camera-compatible, up to 2.5 KV interference resistance, SELV, max. 34 luminaires per circuit (B16A fuse)

76500040 driver unit, DALI, 220-240 V / 50-60 Hz, 700 mA, with GST18/5-pin connector, incl. 5-conductor feed-through wiring, camera-compatible, up to 2.5 KV interference resistance, SELV, max. 24 luminaires per circuit (B16A fuse)

Note: All data are typical values. System features may change with product improvements due to technical advances. Errors excepted.

