

## Ontero CS 90

Article number: 20500002

### LIGHT TECHNOLOGY

|                      |          |
|----------------------|----------|
| LED                  | COB      |
| Light colour         | 835      |
| Luminous flux        | 2190 lm  |
| System power         | 15 W     |
| Luminaire Efficiency | 139 lm/W |
| Reflector            | Spot     |
| Beam angle           | 15°      |

### LUMINAIRE

|                           |              |
|---------------------------|--------------|
| Rotation angle            | 350°         |
| Swivel angle              | +180° / -20° |
| Weight                    | 1.3 kg       |
| Protection rating . class | IP 20 . I    |
| Luminaire colour          | stratoblack  |



Surface-mounted luminaire with LED, rated life of the LED L80/B10 > 50000 h, colour rendering index CRI > 80, chromaticity tolerance 2 SDCM (initial), reflector with circular light distribution pattern, reflector pure aluminium 99,99% in MIRO-Silver®, luminaire head die-cast aluminium, powder-coated, rotation angle 350°, swivel angle +180°/-20°, luminaire housing sheet steel, powder-coated, stratoblack

Multiadapter black, inclusive driver unit: 220-240 V~ / 50-60 Hz, max. 34 luminaires per circuit (B16A fuse)

Note: All data are typical values. System features may change with product improvements due to technical advances. Errors excepted.

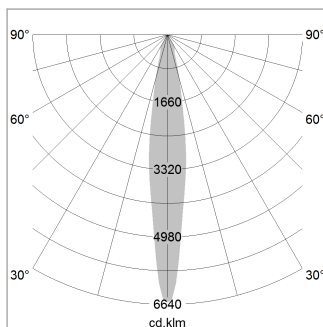

|       |       |            |
|-------|-------|------------|
| 1.0 m | 0.28  | 14062.0    |
| 2.0 m | 0.56  | 3516.0     |
| 3.0 m | 0.84  | 1563.0     |
| 4.0 m | 1.12  | 879.0      |
| 5.0 m | 1.40  | 563.0      |
|       | Ø (m) | E0(0°)(lx) |

