

Ontero IC

Article number: 21440076

LIGHT TECHNOLOGY

LED	COB
Light colour	SpecialMeat
Luminous flux	1770 lm
System power	34 W
Luminaire Efficiency	52 lm/W
Reflector	Spot
Beam angle	20°

LUMINAIRE

Rotation angle	330°
Swivel angle	+/- 90°
Weight	1.1 kg
Protection rating . class	IP 20 . II
Luminaire colour	stratoblack

OPTIONAL

RAL-colours, NCS-colours (powder coating or wet spraying) on inquiry, surface alloys on inquiry, changeable reflector, OvalBeam lens or honeycomb louve, Casambi model on inquiry

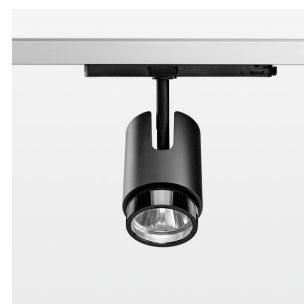
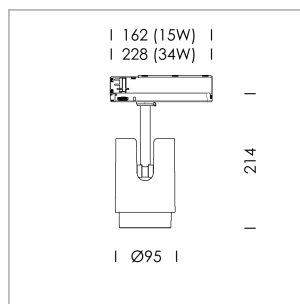

Surface-mounted luminaire with LED, rated life of the LED L80/B10 > 50000 h, chromaticity tolerance 2 SDCM (initial), LED hybrid technology, 3D silicone lens to reduce the proportion of scattered light, reflector with circular light distribution pattern, reflector pure aluminium 99,99% in MIRO-Silver®, segmented and faceted, exchangeable reflector unit in high-sheen black plastic, with glass cover, luminaire head die-cast aluminium, powder-coated, rotation angle 330°, swivel angle +/-90°, luminaire head/retention arm die-cast aluminium, stratoblack

In-Track-Adapter, Fix Current, black,
max. 50 luminaires per circuit (B16A fuse)

Note: All data are typical values. System features may change with product improvements due to technical advances. Errors excepted.

