

Ontero XR

Article number: 20530011

LIGHT TECHNOLOGY

LED	COB
Light colour	927
Luminous flux	1490 lm
System power	15 W
Luminaire Efficiency	99 lm/W
Reflector	Spot
Beam angle	20°

LUMINAIRE

Rotation angle	330°
Swivel angle	+85° / -85°
Weight	0.54 kg
Protection rating . class	IP 20 . II
Luminaire colour	stratosilver

OPTIONAL

RAL-colours, NCS-colours (powder coating or wet spraying) on inquiry (only luminaire head and holding arm), surface alloys on inquiry, Casambi on inquiry, honeycomb louver, blends

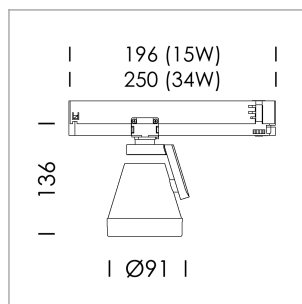

Surface-mounted luminaire with LED, rated life of the LED L80/B10 > 50000 h, colour rendering index CRI > 90, chromaticity tolerance 2 SDCM (initial), reflector with circular light distribution pattern, reflector pure aluminium 99,99% in MIRO-Silver®, rotation angle 330°, swivel angle +85°/-85°, luminaire head/retention arm die-cast aluminium, powder-coated, stratosilver

In-Track-Adapter, black, inclusive driver unit, Fix Current, 220-240 V~ / 50-60 Hz, max. 30 luminaires per circuit (B16A fuse)

Note: All data are typical values. System features may change with product improvements due to technical advances. Errors excepted.

