

Pendiro CP 300

Article number: 81100121

LIGHT TECHNOLOGY

LED	COB
Light colour	Fish-Seafood
Luminous flux	2360 lm
System power	41 W
Luminaire Efficiency	58 lm/W
Reflector	OvalBasic
Beam angle	60° x 40°

LUMINAIRE

Swivel angle	+25° / -25°
Weight	3.2 kg
Protection rating . class	IP 20 . I
Luminaire colour	stratosilver

OPTIONEEL

RAL-colours, NCS-colours (powder coating or wet spraying) on inquiry, surface alloys on inquiry, honeycomb louver

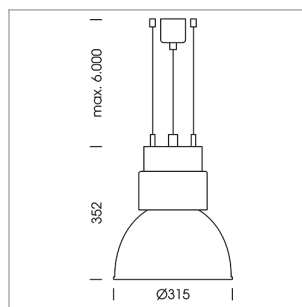

Suspended luminaire with LED, rated life of the LED L80/B10 > 50000 h, colour rendering index CRI > 80, chromaticity tolerance 3 SDCM (initial), reflector with oval light distribution pattern, reflector pure aluminium 99,99% in MIRO-Silver®, luminaire shade die-cast aluminium, powder-coated, swivel angle +25°/-25°, luminaire housing sheet steel, powder-coated, stratosilver

Multiadapter black, inclusive driver unit: 220-240 V~ / 50-60 Hz, max. 24 luminaires per circuit (B16A fuse), mit 3650Ohm

Note: All data are typical values. System features may change with product improvements due to technical advances. Errors excepted.

